

WARMAIR



Contents

Introduction	1
Product Range	2
Dimensions & Capacities	3
Furnace <i>C/W</i> By-Pass	4
Performance Tables	5
Warranty	6

Celmecc International Leading the way in Air Control, Heating & Cooling

At Celmecc International, it is our belief that working closely with our clients aids the mutual success of both organisations and for this reason we have adopted the following mission:

“To excel in the commercial and industrial building industry by setting new standards with innovative products through leadership, first class customer service and engineering excellence.”

It is with confidence that we at Celmecc International offer our WarmAir heating as part of our unique Coolheat product range. Our WarmAir units are tried and proven for well over two decades.

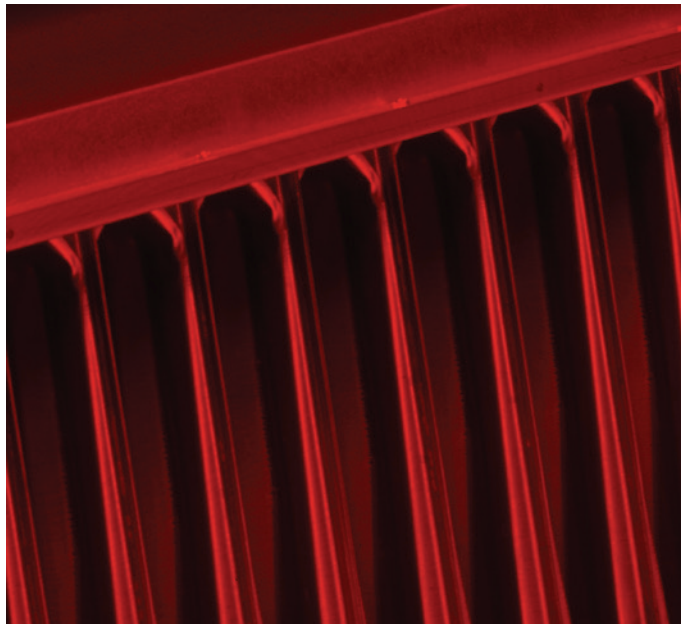

Duct and Unit WarmAir Gas Fired Heating

X - Duct Heaters (indoor)

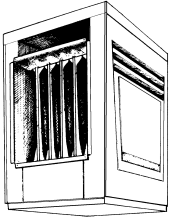

The full heater range is well proven with regard to reliability, efficient performance and the high quality of construction and materials.

The X series heaters are designed for use indoors as integral heating components of heating, heating/cooling, or make-up air systems. Air can be passed through the heater in either direction permitting choice of access to the control panel located on the side of the unit.

Heat transfer system: Stainless Steel all welded heat exchanger.

Mounting: Designed to stand on a non-combustible base or can be suspended.

RX - Duct Heaters (rooftop)

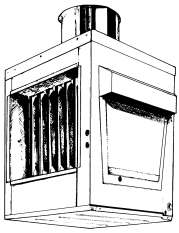

RX Series units are of weatherproof construction, designed for use as integral heating components of heating, heating/cooling, or make-up air systems. These units are supplied complete with a flue cowl fitted as standard equipment, together with screened weatheguard combustion air inlet hoods.

Heat transfer system: Stainless Steel all welded heat exchanger.

Mounting: Designed to stand on a non-combustible platform.

XC, RXC - Unit Heaters (with enclosed centrifugal fan)

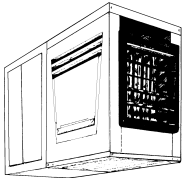

XC and RXC unit heaters are fitted with a centrifugal fan assembly completely enclosed, incorporating removable side access panels. These units are designed for commercial and institutional applications, where good appearance is of essence. The fan enclosure also facilitates optional acoustic treatment and mounting of air filters if required.

Volume V.S. Resistance (pressure drop over heat exchanger)

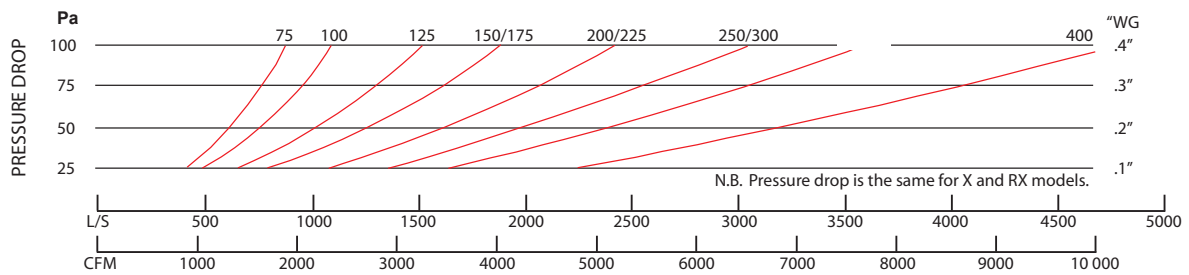

X, RX, XC, RXC Gas Fired Heaters (natural or propane gas)

MODEL	75	100	125	150	175	200	225	250	300	400
Input MJ/h	79	106	132	158	184	211	237	263	316	422
Output kW	17	23	28	34	40	46	51	57	69	92
Nominal Air Delivery L/S	425	575	700	900	1000	1200	1300	1475	1750	2300
Motor kW (standard)	.37	.37	.37	.37	.37	.55	.55	.55	.75	1.1

Design external static pressure: 70 Pa.
Higher air quantities with larger motor on application (XC, RXC).
All units fitted with electronic ignition.
Standard control - ON/OFF.

Gas Supply

Manifold pressure

Inlet pressure

Gas connection

3/4" BSP - Models 75-225, 1" BSP - Models 250-400

NG

0.9kPa

1.1-3.0kPa

LPG

2.5kPa

2.75kPa

Duct and Unit WarmAir Gas Fired Heating

X, RX SERIES

RG, RX FLUE SPIGOT SITUATED IN CENTRE OF CABINET TOP WITH COWL SUPPLIED.

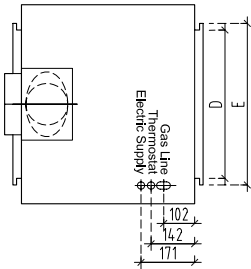

TOP VIEW
X

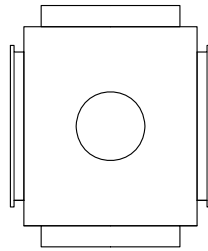

TOP VIEW
RX

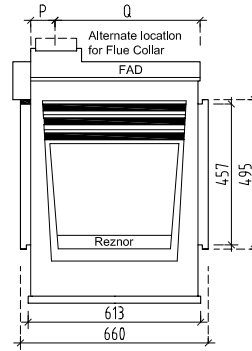

SIDE
X, RX

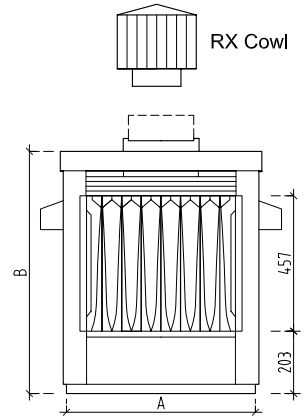

FRONT
X, RX

NOTES:

- i All units fitted with electronic ignition, not permanent pilot.
- ii Electrical connections are on L/H side when facing air outlet, 240V connection / 24V transformer for control circuit.
- iii Unit Fan motors also available in 415V / 3 Ph.
- iv Computer designed fan and motor assemblies for non-standard air requirements when specified.
- v Optional flue ventors available for use with all models.

DIMENSIONS (mm) X, RX Series - Duct Heaters

MODEL	A	B	D	E	P	Q	FLUE COLLAR X, RX		FLUE DIAM	GAS CONN NAT/ LPG	WEIGHT approx. (kg)	
	X,RX	X, RX							X, RX		X	RX
75	490	820	320	355	85	525	round	125	127	20	70	75
100	490	820	320	355	85	525	round	150	125	20	70	75
125	555	820	385	425	85	525	152	192	178	20	80	85
150	700	820	525	565	85	525	152	233	203	20	85	90
175	700	820	525	565	85	525	152	233	203	20	85	90
200	835	895	665	705	125	490	round	200	203	20	100	105
225	835	895	665	705	125	490	round	200	203	20	100	105
250	1050	895	875	915	125	490	229	268	254	25	125	130
300	1050	895	875	915	125	490	229	268	254	25	125	130
400	1330	895	1155	1195	125	490	229	348	305	25	160	165

CAPACITIES

MODEL	75	100	125	150	175	200	225	250	300	400
INPUT MJ/h	79	106	132	158	184	211	237	263	316	422
OUTPUT kW	17	23	28	34	40	46	51	57	69	92
NOMINAL L/S	425	575	700	900	1000	1200	1300	1475	1750	2300

DIMENSIONS (mm) XC, RXC Series (with enclosed centrifugal fan)

WIDTH	490	490	555	700	700	835	835	1050	1050	1330
HEIGHT	820	820	820	820	820	895	895	895	895	895
LENGTH - XC, RXC	1500	1500	1500	1500	1500	1500	1500	1500	1500	1500
WEIGHT (kg) approx. - XC - RXC	100	100	130	150	150	160	160	190	190	240
	105	105	135	155	155	165	165	200	200	250

Furnace C/W By-Pass

RX FLUE SPIGOT SITUATED
IN CENTRE OF CABINET TOP

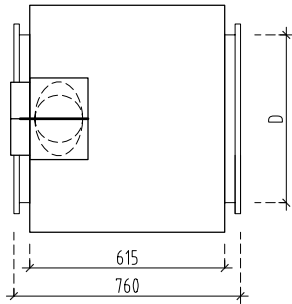

PLAN VIEW

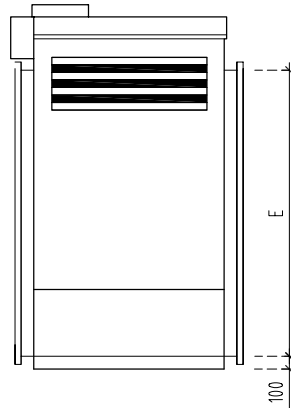

SIDE VIEW

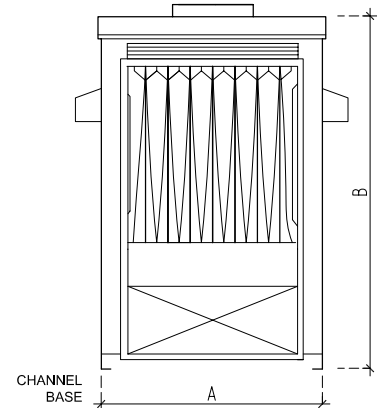

FRONT VIEW

DIMENSIONS (mm) X, RX Series - C/W By-Pass								
MODEL	LPS	A	B	D	E	FLUE COLLAR		FLUE DIA.
		X, RX	X, RX			X, RX	X, RX	
75	2000	490	1130	320	960	Round	127	127
100	2000	490	1130	320	960	Round	152	152
125	2500	555	1130	385	960	152	192	178
150	4000	700	1250	525	1080	152	233	203
175	4000	700	1250	525	1080	152	233	203
200	5000	835	1325	665	1080	Round	203	203
225	5000	835	1325	665	1080	Round	203	203
250	7500	1050	1525	875	1280	229	268	254
300	7500	1050	1525	875	1280	229	268	254
400	10000	1330	1525	1155	1280	229	348	305

REF: 080499-3

Performance Tables

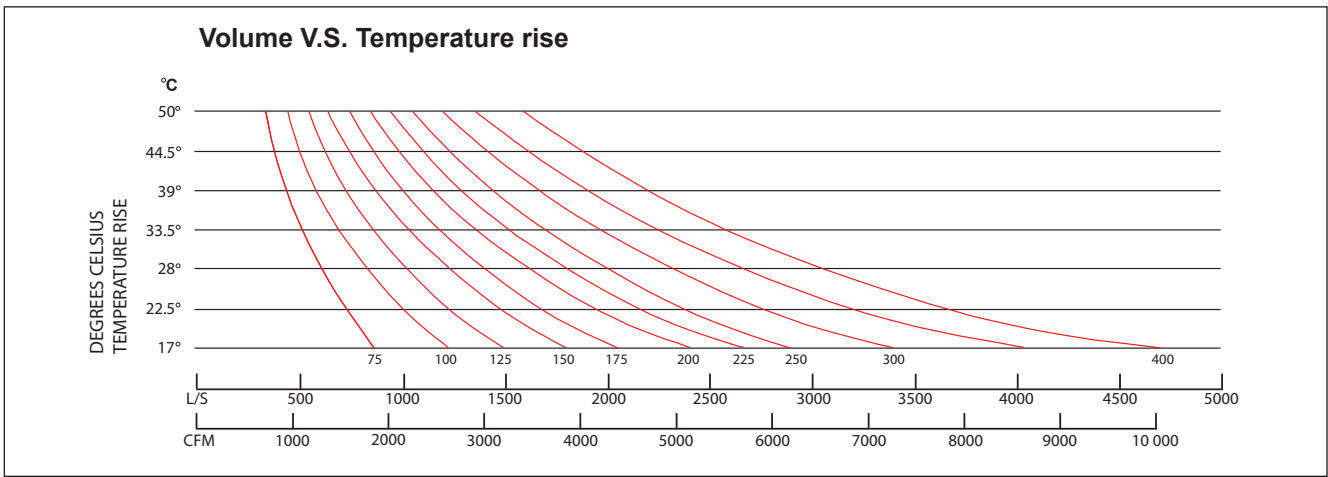
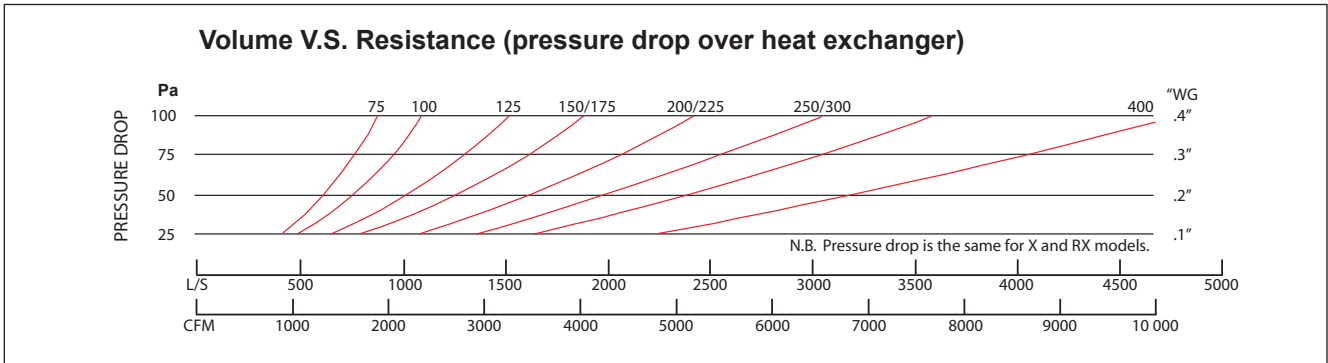

Optional Equipment

Modulation - Electronic

Louvres - Horizontal and/or vertical

Power Flue Ventr - Motorised flue gas exhauster. Permits long lateral flue runs and exhaust through side walls. Uses 100 dia or 150 dia pipe. Positive venting requires heat adapter.

POWER FLUE VENTOR					
DIMENSIONS (mm)				RATING	
SERIES	HEIGHT	WIDTH	LENGTH	BTU x 000	MJ
301	190	250	180	35 - 300	37 - 317
401	240	270	220	350 - 400	369 - 422



CELMEC INTERNATIONAL PTY. LTD. ACN 005 850 546

WarmAir, Ducted and Unit Heaters

WARRANTY

Celmece International warrants to the original owner-user that all Celmece products will be free from defects in materials and workmanship. This warranty is limited to twelve (12) months from the date of despatch.

Aluminised Steel Heat Exchangers are not covered by the Celmece Warranty if used in conjunction with air conditioning or when the inlet temperature is below 4.5°C. Stainless Steel Heat Exchanger units must be used for these installations.

Limitations and Exclusions

Celmece's obligation under this warranty is limited to repair or replacement at Celmece's factory, Moorabbin, of any parts of the product identified by model or serial number which shall be returned to Celmece with transportation charges prepaid and which Celmece's examination shall disclose to its satisfaction to be defective.

No parts will be supplied (in exchange for those defective or requiring repair) in advance of receipt and examination of the returned parts.

The manufacturer does not participate in any site related costs or labour expenses incidental to the replacement of parts, repairing, removing, installing, servicing, or handling of parts or complete products and assumes no liability on parts repaired or replaced without consent.

All warranty requests for repairs or replacements must be accompanied by an installation commissioning report and a written explanation, giving model, serial number of unit and details of fault.

There is no warranty expressed or implied with regard to capacity requirements. The selection of the appropriate unit or units depends entirely upon the system design and capacities as determined and specified by the purchaser.

This warranty does not apply to any unit or parts thereof which become inoperative due to accident, misapplication, abuse, misuse, unauthorised alterations, or operation contrary to Celmece's wiring diagrams and printed instructions, or if the serial number has been altered, defaced or removed.

Celmece shall not be liable for any default or delay in performance of its warranty obligations hereunder caused by any circumstances beyond its control, including but not limited to judicial or government restrictions or restraints, strikes, fires, floods, or delayed supplies of raw materials or parts.

All goods are thoroughly inspected and tested before despatch and are at the risk of the purchaser after shipment leaves Celmece's factory. Should the goods arrive damaged, make the transport company aware of their condition and have this noted on the freight bill. If damage is discovered after unpacking, demand immediate inspection by the transportation company and insist that a notation is made of the damage on the freight bill.



Melbourne — HQ
19 Simpson Street,
Moorabbin VIC 3189
T +61 3 8552 8200

Sydney
401/460 Pacific Hwy,
St Leonards NSW 2065
T +61 2 8436 7200

celmec.com.au
info@celmec.com.au